

process measurement solutions



Mobrey Mini-Squing

the vibrating level switch from
Solartron Mobrey

IP210



Mini-Squing short fork technology

The Mini-Squing is designed using the principles of a tuning fork. Piezo-electric crystals are used to force the forks to oscillate at their fundamental frequency (natural resonance).

If the Mini-Squing is installed as a high alarm, the forks are free to oscillate in air; as your liquid level rises and covers the forks they are dampened - it is this change in the frequency that indicates the Mini-Squing to switch. With different electronic outputs to choose from, this allows you to switch a load on/off or interface directly with your PLC.

A compact switch with a rugged stainless steel body for use in a wide range of liquids, Mini-SQUING is the stock answer to your level switch needs.

Features

- ▶ Economical $\frac{3}{4}$ " mounting in pipes or tanks
- ▶ Hygienic mounting for food industry use
- ▶ Small fork size for minimal intrusion into vessel
- ▶ Heartbeat LED gives status and health information
- ▶ Protection against reverse polarity and short circuit connection

Benefits

- ▶ Continuous operating temperature of 150°C and pressure to 100 bar g
- ▶ Operating frequency chosen to avoid false switching from plant vibration
- ▶ Industry standard plug/socket connection for fast easy connection.
- ▶ Direct load switching model suits all supplies: 24 to 264V ac/dc, 50/60Hz.
- ▶ 24V dc Solid state PNP output for direct interface to PLCs.

It's simple to order. Just choose from the 6 process connections with either direct load switching or PNP/PLC switching output. For example, a $\frac{3}{4}$ " BSPT threaded version to be used for switching a load: order the VT00.

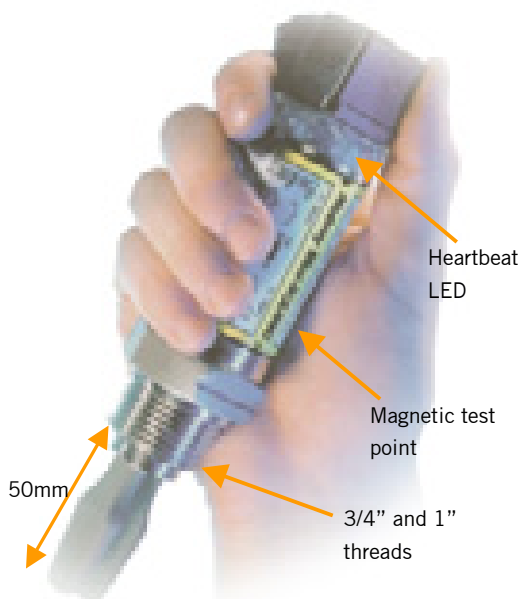

Two year warranty
Next day delivery

Model nos. for order		Mounting thread	A	B	C	D
Direct load switching	PNP switching					
VT00	VT10	$\frac{3}{4}$ " BSPT	69	50	188	N/A
VT05	VT15	$\frac{3}{4}$ " NPT	69	50	188	N/A
VT03	VT13	1" BSPT	69	50	188	N/A
VT0F	VT1F	1" BSPP	78	60	201	N/A
VT07	VT17	51mm 2" Tri-Clover	69	50	188	64
VT0L	VT1L	1" BSPP Semi-extended	116	98	239	N/A

Dimensions

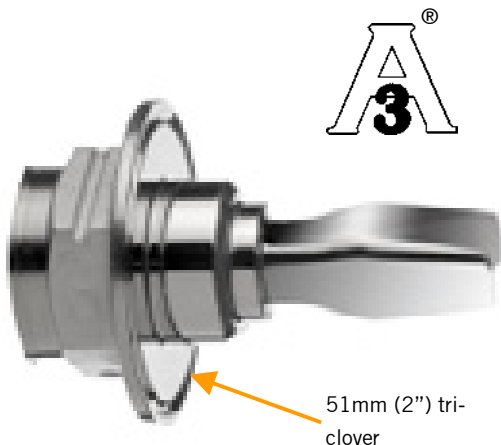
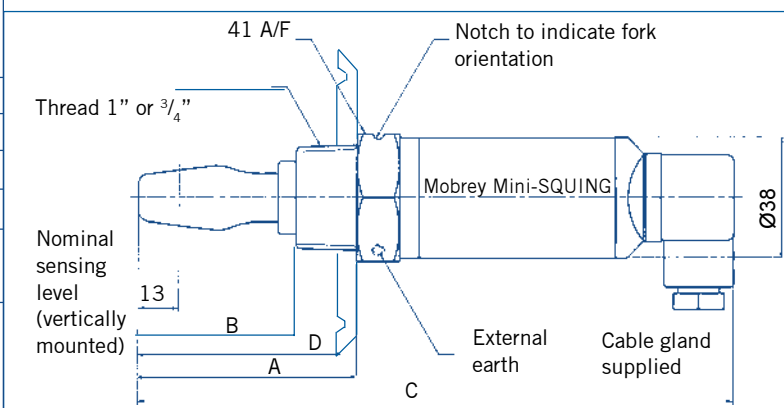

Hygienic applications

Where hygiene is important, Solartron Mobrey offers a companion mounting boss which is for use with the 1" BSPP Mini-Squing, or the industry standard 51mm (2") Tri-clover mounting flange. With its hand polished wetside and surface finish (Ra) better than $32\mu\text{m}$, it is suitable for use where 3A and EHEDG approvals are required.



- SK266 Hygienic mounting kit for use with 51mm (2") Tri-clover model
- SK267 Hygienic mounting boss for use with 1" BSPP model
- SK331 Spare gasket (kit of 5) for use with 1" BSPP model

Applications

Overfill protection

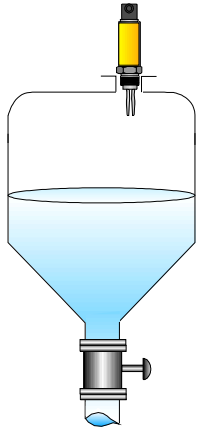

- Simple
- Cost effective
- Failsafe
- Heartbeat LED

Spillages caused by overfilling can be very expensive, not only in lost product and unnecessary downtime, but also in clean-up costs and heavy fines if the environment or personnel are contaminated. Regulations are in draft form to ensure suitable prevention measures are in place.

The simple and cost effective way to get ahead of the game is the Mobrey Mini-Squing – a failsafe limit switch with a built-in heartbeat LED to tell you it is ready to detect and signal overfill at any time.

Pump protection

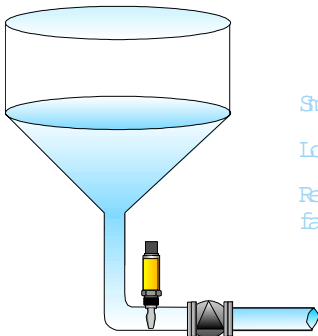

- Small forks
- Low cost
- Resistance to false switching

Pumps are not cheap. Damage a pump by running dry and the costs multiply, not least being equipment replacement and consequent downtime.

Prevention is easy – the Mobrey Mini-Squing with its small forks and superior resistance to false switching will mount directly into the pipe – a low cost solution with the added benefit of emptying all the tank contents rather than leaving some behind.

High level alarm

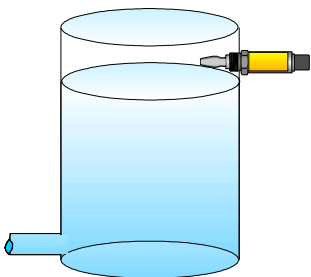

- Economical
- Reliable
- Minimal maintenance
- Manual test facility

Many processes are controlled by plant computers, and tank levels are often measured by transmitters. It is common practice to fit an independent high level alarm switch to provide extra back up to the transmitter in case of failure.

The economical answer is the Mobrey Mini-Squing – a reliable level switch with minimal maintenance requirement, which includes a manual test facility so that the switch may be tested at any time without removing it from the vessel or raising the liquid level.

Leak detection

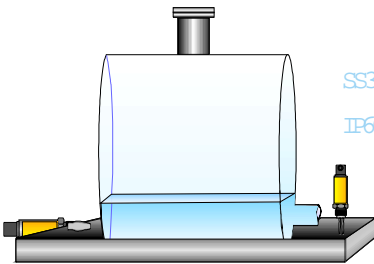

- SS316 housing
- IP66/67

Flanges, gaskets, seals, corrosive liquids – they all have the potential to cause leaks at the most inconvenient times. Many users site tanks and vessels above trays or in bunds to contain any liquids which may escape, but they need to know quickly if there is a leak.

The Mobrey Mini-Squing is an ideal product to install in the catchment area to detect if liquid starts to collect. A stainless steel housing with a IP66/67 rating allows installation in almost any environment.

Pump control

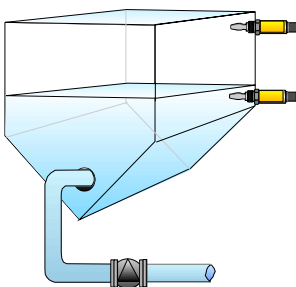

- Lightweight
- 316SS mounting boss
- 3/4" threaded model
- Threaded boss

Many processes have batching and header tanks, and there is usually the need to control a pump to maintain levels between set points, keeping the process supply line going. These tanks are often manufactured from thin wall materials and cannot support the weight of heavy instrumentation.

Mobrey Mini-Squing solves the problem, being lightweight and requiring only a threaded boss for mounting. The 3/4" threaded model is the lightest, while the 51mm (2") Tri-clover model can be supplied with a hygienic mounting boss kit, making installation in food and beverage processes simplicity itself.

Technical specification

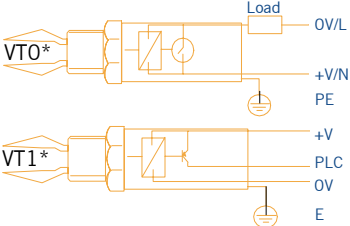
Application & mounting	Most liquids, including coating and aerated liquids, slurries. For use in safe area only. Mount in any position in tank or pipe. Mounting is by $\frac{3}{4}$ " or 1" thread, or hygienic 51mm (2") Tri-clover flange. (see table on page 2)																												
Construction	Wetside material 316L Stainless steel (1.4404) Gasket (1" BSPP model only) Non-asbestos (BS7531 Grade X carbon fibre with rubber binder) Dryside materials Body 304 Stainless steel with polyester label LED window Flame retardant Polyamide (Pa12) 12 UL94 V2 Plug Polyamide (+G) Plug seal Nitrile butadiene rubber Ingress of protection rating IP66/67 to EN60529																												
Operating conditions	Wetside temperature range -40°C to +150°C CIP cleaning 10,000 cycles up to 130°C for 30 minutes. Ambient temperature range -40°C to +80°C (derated to 50°C at 150°C wetside) Wetside pressure range -0.25 bar g to +100 bar g at 50°C Liquid specific gravity range 0.6 to 2.0 Liquid viscosity range 0.2 to 10,000 cps Switching point (water) 13mm from tip (vertical) / from edge (horizontal) of fork Hysteresis (water) +/- 1mm nom. Switching delay 1 sec dry to wet / wet to dry.																												
Electrical	<table border="1"> <thead> <tr> <th></th> <th>Direct load switching VTO*</th> <th>pnp Switching VT1*</th> </tr> </thead> <tbody> <tr> <td>Operating voltage:</td> <td>21 to 264V ac (50/60Hz)/dc</td> <td>18-60V dc</td> </tr> <tr> <td>Max. switched load:</td> <td>500mA</td> <td>500mA</td> </tr> <tr> <td>Max. peak load:</td> <td>5A</td> <td>5A</td> </tr> <tr> <td>Min switched load:</td> <td>20mA continuous</td> <td>-</td> </tr> <tr> <td>Voltage drop:</td> <td>6.5V @ 24V dc / 5.0V @ 240V ac</td> <td><3V</td> </tr> <tr> <td>Current drawn (load off):</td> <td><3.0mA continuous</td> <td>-</td> </tr> <tr> <td>Supply current:</td> <td>-</td> <td>3mA nominal</td> </tr> <tr> <td>Output current (load off):</td> <td>-</td> <td><0.5mA</td> </tr> </tbody> </table>			Direct load switching VTO*	pnp Switching VT1*	Operating voltage:	21 to 264V ac (50/60Hz)/dc	18-60V dc	Max. switched load:	500mA	500mA	Max. peak load:	5A	5A	Min switched load:	20mA continuous	-	Voltage drop:	6.5V @ 24V dc / 5.0V @ 240V ac	<3V	Current drawn (load off):	<3.0mA continuous	-	Supply current:	-	3mA nominal	Output current (load off):	-	<0.5mA
	Direct load switching VTO*	pnp Switching VT1*																											
Operating voltage:	21 to 264V ac (50/60Hz)/dc	18-60V dc																											
Max. switched load:	500mA	500mA																											
Max. peak load:	5A	5A																											
Min switched load:	20mA continuous	-																											
Voltage drop:	6.5V @ 24V dc / 5.0V @ 240V ac	<3V																											
Current drawn (load off):	<3.0mA continuous	-																											
Supply current:	-	3mA nominal																											
Output current (load off):	-	<0.5mA																											
Switching mode selection  Protection Cable connection Earthing	Reverse polarity protected. Missing load / short circuit protection. Via 4 way plug provided – DIN43650 Max. conductor size – 15AWG Orientation – 4 position (90/180/270/360 deg.) Cable gland provided – cable dia. 6mm to 8mm. Mini-SQUING should always be earthed either through cable plug or using external earth connection provided.																												
Approvals	E.M.C. Directive EN50081-1 (Emissions) / EN50082-2 (Immunity) / EN61326 L.V. Directive EN61010-1 Pollution degree 2, Category II (264V max) Pollution degree 2, Category III (150V max)																												
Warranty	Solartron Mobrey will replace a faulty or failed Mini-SQUING with a new unit provided that the fault or failure is reported either directly or via an accredited Agent, within a period of 2 years from the date of supply, and the product has been installed and used in accordance with Mobrey instruction manual IP2022. Solartron Mobrey reserves the right to examine such product and to refuse replacement at its discretion if the above conditions are not met.																												

Solartron Mobrey Limited

158 Edinburgh Avenue Slough Berks UK SL1 4UE
 Tel: +44 (0)1753 756600 Fax: +44 (0)1753 823589
 e-mail: sales@solartron.com www.solartronmobrey.com



Solartron Mobrey GmbH	Deutschland	tel: 0211/99 808-0
Solartron Mobrey Ltd	China	tel: 021 6353 5652
Mobrey sp z o o	Polska	tel: 022 871 7865
Solartron Mobrey AB	Sverige	tel: 08-725 01 00
Mobrey SA	France	tel: 01.34.30.28.30
Solartron Mobrey SA-NV	Belgium	tel: 02/465 3879
Solartron Mobrey	USA	tel: (281) 398 7890

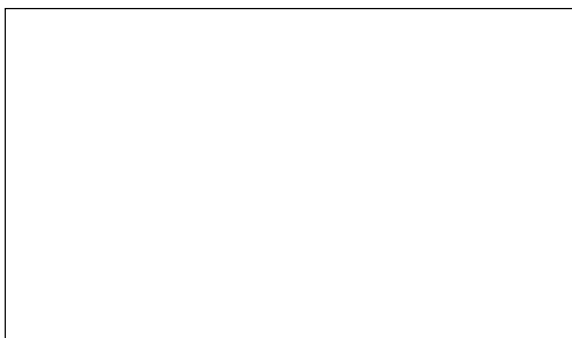

The right is reserved to amend details given in this publication without notice